

Name **SPREADERLIGHT 230V**
 Number **N030**
 Collection **NAUTIC**

TEKNA

General

Location Indoor/outdoor
 Main material Brass/glass
 IP rating IP 65
 Class I
 Bathroom zone Zone 3
 Voltage 230V
 Driver required No
 Cable length (m) Internal connection
 Dimensions (mm) W80mm - H130mm - D85,5mm.
 Mounting method Wall mounting
 Brut weight (kg) 1,5
 Gross weight (kg) 1
 Packing (mm) 180x150x90
 Energy Efficiency % A



Lamp

Included
 Light source Led module 230V
 Number of light sources .
 Socket type .
 Bulb shape .
 Max lamp length (mm) .
 Power consumption 4W
 Luminous Flux 360lm
 Color temperature 2700K
 CRI 90
 Lifetime .
 Beam angle .

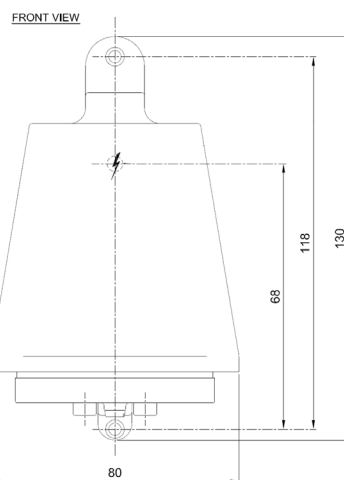





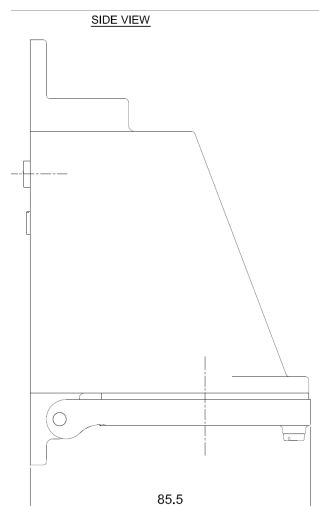

Electrical

Switched No
 Battery No
 Dimmable Yes
 Dimming range See dimming list
 Dimming method Phase dimming
 Supply frequency 50/60Hz
 Driver/ballast voltage 220-240V
 Efficiency .



Finishes

 Dark Bronze
 Polished Brass
 Rough Dark Bronze
 Polished Chrome Plated Brass
 Brushed Chrome Plated Brass
 Acid Green