

## XOB Light Source

Xicato designs and develops light sources and electronics that enable architects, designers and building managers to create beautiful, smart spaces in which people love to live and work. With thousands of installations around the globe, Xicato continues to be a leading supplier of high quality lighting solutions. Xicato is defining the future of intelligent light sources by integrating electronics, software and connectivity. Founded in 2007, Xicato's headquarters is based in Silicon Valley and the company has offices in China, Europe and the US.

For further information, visit [xicato.com](http://xicato.com).

# XOB



XOB is a Chip on Board (COB) LED light source compatible with industry standard holders, heatsinks, reflectors and lenses used in a variety of downlight and spot fixtures. XOB provides high quality light with a white point that perfectly matches other Xicato products, including XTM and XIM.

XOB delivers Xicato's award-winning color points, unmatched color rendering, and great performance in an industry standard form factor that allows for rapid fixture design resulting in accelerated time to revenue.

1 x 2 SDCM

Color & flux warranty

2700K to 4000K CCT

LES sizes range from 4 to 32mm

345lm – 8300lm

90, 95, Vibrant95

2700K-4000K	90 CRI	95 CRI
XOB04	380-455 lm	345-415 lm
XOB06	850 - 950 lm	750 - 900 lm
XOB09	1,400 - 1,600 lm	1,250 - 1,450 lm
XOB14	4,000 - 4,800 lm	3,600 - 4,300 lm
XOB23	4,950 - 5,850 lm	5100 - 5600 lm
XOB32	7,050 - 8,300 lm	

Typical measurements at Tc=70°C and max If for each LES.

## Packages and Operation

### Package Options

LES 4.5mm, 13.5 mm x 13.5 mm x 1.4 mm – 450 mA

LES: 6 mm, 13.5 mm x 13.5 mm x 1.4 mm - 250 mA

LES: 9.8 mm, 13.5 mm x 13.5 mm x 1.4 mm - 350 mA

LES: 14.5 mm, 19 mm x 19 mm x 1.4 mm - 1050 mA

LES: 23 mm, 28 mm x 28 mm x 1.4 mm - 1400 mA

LES: 32.8 mm, 38 mm x 38 mm x 1.4 mm - 1400 mA

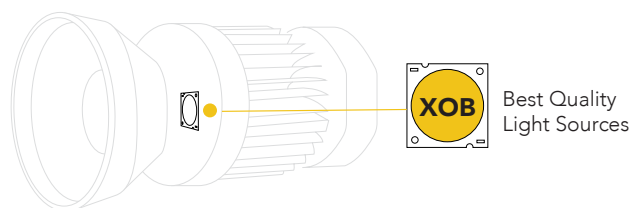



## Table of Contents

General Description	2
Table of Contents	3
Ordering Guide	4
Performance Characteristics XOB04 Product Selection Table	5
Performance Characteristics XOB06 Product Selection Table	6
Performance Characteristics XOB09 Product Selection Table	8
Performance Characteristics XOB14 Product Selection Table	10
Performance Characteristics XOB23 Product Selection Table	12
Performance Characteristics XOB32 Product Selection Table	14
Color Specifications	16
Mechanical Drawings	19
Regulatory Information	20

# Ordering Guide

## Part Numbering System and Nomenclature

XOB	06	95	27	10	X	33	2	1
XOB	LES	Minimum CRI	CCT	Flux Range	Color Point	Max Voltage	2: 1 x 2 SDCM	Rev.
	04: 4.5mm	90	27: 2700K	04: 400 lm	X: Xicato	09		
	06: 6 mm	95	30: 3000K	10: 1,000 lm	V: Vibrant	33		
	09: 9.8 mm		35: 3500K	15: 1,500 lm		36		
	14: 14.5 mm		40: 4000K	30: 3,000 lm		51		
	23: 23 mm			50: 5,000 lm				
	32: 32.8 mm			60: 6,000 lm				
				90: 9,000 lm				

## Absolute Operating Conditions

LES (mm)	Rth, j-c (°C/W)	Minimum Vf	Max LED Junction Temperature Tj (°C) <sup>1</sup>	Max Vf (V)	Max Drive Current (mA) <sup>3</sup>	Warrantied Drive Current (mA) <sup>4</sup>
4.5		7.8	125	9.4		450
6	1.21	28.1	125	34.1	300	250
9.8	0.5	30.3	125	36.9	500	350
14.5	0.34	30.5	125	37	1400	1,050
23	0.44	30.6	125	37.2	2100	1,400
32.8	0.22	43	125	52.2	2100	1,400

Notes:

1. Max Tj is based on UL 8057 testing
2. Max Tc can be derived from Rth,j-c and input power to XOB at max allowed drive current
3. Max drive current is based on IEC62717 testing
4. Warranty coverage for flux and color shift applies as long as these operating conditions are met
5. Current derating curves are provided in later sections
6. Overdriving above warranty max current invalidates color shift warranty

# Performance Characteristics

1. Data shown in the tables below are taken at a recommended operating test point (Tc) temperature of 70°C.
2. Voltage data is based on 20°C to 90°C operating range.
3. XOB is designed for use with a constant current power supply with maximum output current.
4. Minimum, maximum, and typical power consumption can be calculated from the ranges provided.
5. Absolute range of lumen output is ±10% of typical value
6. CCT data ANSI/NEMA compliant.
7. Specifications are subject to change without notice.

## XOB 04

Series	CRI (Typical)	Part Number	Color Temp	Drive Current	Forward Voltage			Power Consumption (Typical)	Lumen Output (Typical)	Efficacy (Typical)
			(K)	mA	Min	Typ	Max	W	lm	lm/W
XOB 04	90	XOB04902704X0921	2700	450	7.8	8.7	9.4	3.9	388	99
				350	7.7	8.6	9.3	3.0	311	103
		XOB04903004X0921	3000	450	7.8	8.7	9.4	3.9	423	109
				350	7.7	8.6	9.3	3.0	339	113
		XOB04903504X0921	3500	450	7.8	8.7	9.4	3.9	445	114
				350	7.7	8.6	9.3	3.0	356	119
	XOB04904004X0921	4000	450	7.8	8.7	9.4	3.9	464	119	
			350	7.7	8.6	9.3	3.0	372	124	
	95	XOB04952704X0921	2700	450	7.8	8.7	9.4	3.9	353	90
				350	7.7	8.6	9.3	3.0	283	94
		XOB04953004X0921	3000	450	7.8	8.7	9.4	3.9	385	99
				350	7.7	8.6	9.3	3.0	308	103
		XOB04953504X0921	3500	450	7.8	8.7	9.4	3.9	405	104
				350	7.7	8.6	9.3	3.0	324	108
	XOB04954004X0921	4000	450	7.8	8.7	9.4	3.9	422	108	
			350	7.7	8.6	9.3	3.0	338	113	
	V9	XOB04953004V0921	V9	450	7.8	8.7	9.4	3.9	385	99
				350	7.7	8.6	9.3	3.0	308	103

# Performance Characteristics

XOB06

Series	CRI (Typical)	Part Number	Color Temp	Drive Current	Forward Voltage			Power Consumption (Typical)	Lumen Output (Typical)	Efficacy (Typical)
			(K)	mA	Min	Typ	Max	W	lm	lm/W
XOB06	90	XOB06902710X3321-B	2700	250	28.1	31.6	34.1	7.9	840	107
				200	27.9	31.3	33.9	6.3	696	111
		XOB06903010X3321-B	3000	250	28.1	31.6	34.1	7.9	873	111
				200	27.9	31.3	33.9	6.3	723	115
		XOB06903510X3321-B	3500	250	28.1	31.6	34.1	7.9	939	119
				200	27.9	31.3	33.9	6.3	778	124
	XOB06904010X3321-B	4000	250	28.1	31.6	34.1	7.9	975	124	
			200	27.9	31.3	33.9	6.3	808	129	
	95	XOB06952710X3321-B	2700	250	28.1	31.6	34.1	7.9	751	95
				200	27.9	31.3	33.9	6.3	622	99
		XOB06953010X3321-B	3000	250	28.1	31.6	34.1	7.9	798	101
				200	27.9	31.3	33.9	6.3	660	105
		XOB06953510X3321-B	3500	250	28.1	31.6	34.1	7.9	859	109
				200	27.9	31.3	33.9	6.3	711	114
	XOB06954010X3321-B	4000	250	28.1	31.6	34.1	7.9	895	113	
			200	27.9	31.3	33.9	6.3	741	118	
	V9	XOB06953010V3321-B	V9	250	28.1	31.6	34.1	7.9	796	101
				200	27.9	31.3	33.9	6.3	659	105

Performance same as older revision (-A)

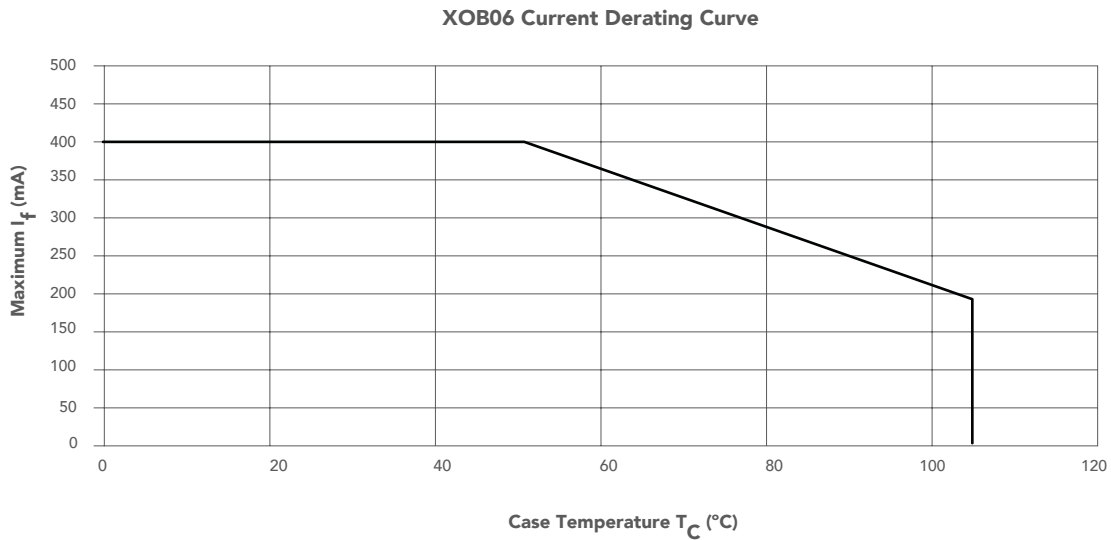
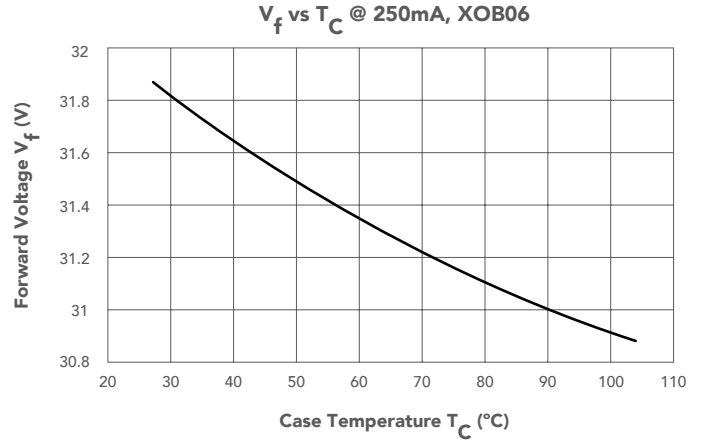
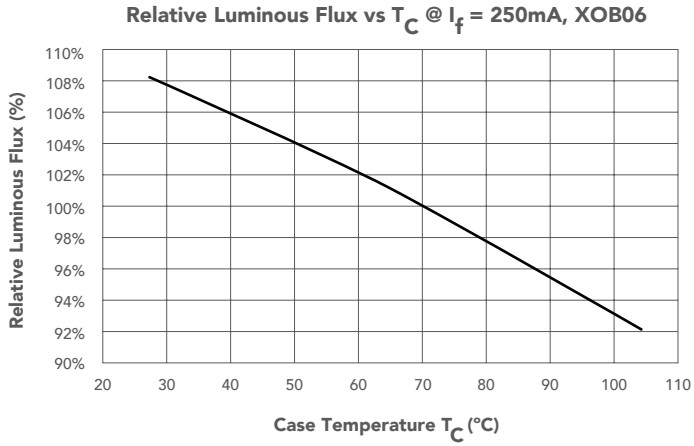
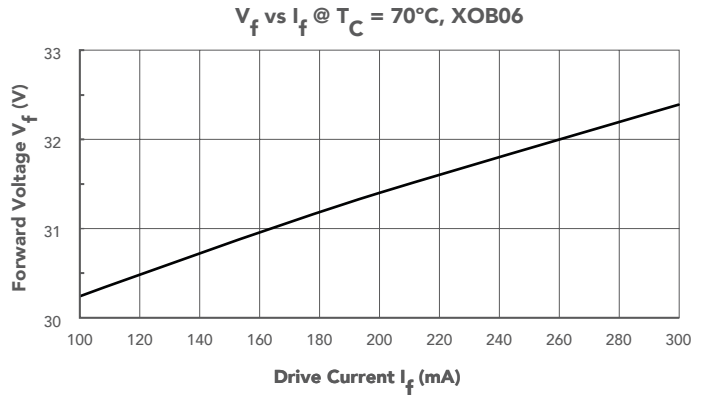
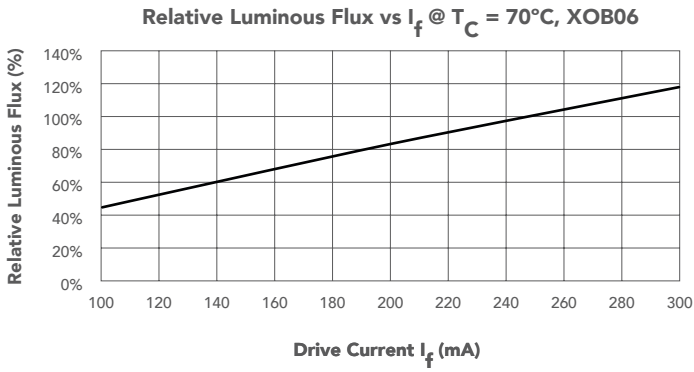

Values in the table above represent 100% relative flux at  $I_f = 250\text{mA}$  and  $T_C = 70^\circ\text{C}$ . To calculate flux under different drive conditions, use the tables and charts above to determine relative flux at different  $I_f$  and  $T_C$  values. For example, in order to calculate the flux when driving a 6mm 95 CRI 3000K XOB at  $I_f = 140\text{mA}$  and  $T_C = 50^\circ\text{C}$ , multiply 800 lumens by 0.6 and then multiply again by 1.04 to get 499 lumens.  $P = I \cdot V$ , so the efficacy for these drive conditions would be  $(499 \text{ lm}) / (0.140 \text{ A} \cdot 30.7 \text{ V}) = 116 \text{ lm/W}$ .

# Performance Characteristics

XOB09

Series	CRI (Typical)	Part Number	Color Temp	Drive Current	Forward Voltage			Power Consumption (Typical)	Lumen Output (Typical)	Efficacy (Typical)
			(K)	mA	Min	Typ	Max	W	lm	lm/W
XOB09	90	XOB09902715X3621	2700	350	30.3	34.0	36.9	11.9	1433	120
				250	30.1	33.8	36.6	8.4	1091	129
		XOB09903015X3621	3000	350	30.3	34.0	36.9	11.9	1513	127
				250	30.1	33.8	36.6	8.4	1151	136
		XOB09903515X3621	3500	350	30.3	34.0	36.9	11.9	1582	133
				250	30.1	33.8	36.6	8.4	1204	143
		XOB09904015X3621	4000	350	30.3	34.0	36.9	11.9	1620	136
				250	30.1	33.8	36.6	8.4	1233	146
	95	XOB09952715X3621	2700	350	30.3	34.0	36.9	11.9	1276	107
				250	30.1	33.8	36.6	8.4	971	115
		XOB09953015X3621	3000	350	30.3	34.0	36.9	11.9	1341	113
				250	30.1	33.8	36.6	8.4	1020	121
		XOB09953515X3621	3500	350	30.3	34.0	36.9	11.9	1421	119
				250	30.1	33.8	36.6	8.4	1081	128
		XOB09954015X3621	4000	350	30.3	34.0	36.9	11.9	1483	124
				250	30.1	33.8	36.6	8.4	1129	134
	V9	XOB09953015V3621	V9	350	30.3	34.0	36.9	11.9	1347	113
				250	30.1	33.8	36.6	8.4	1020	121



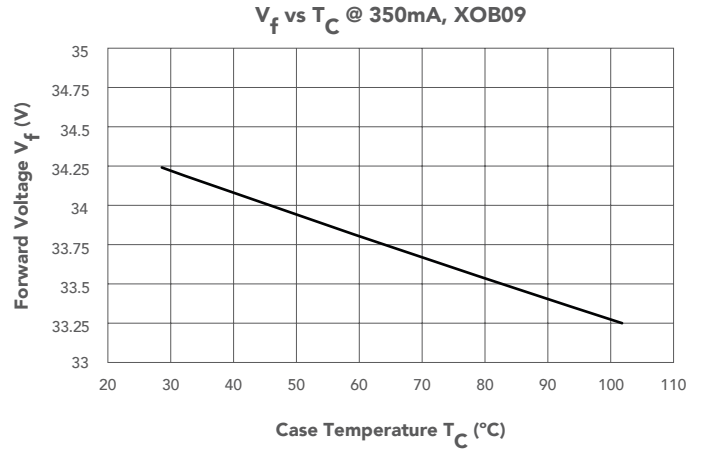
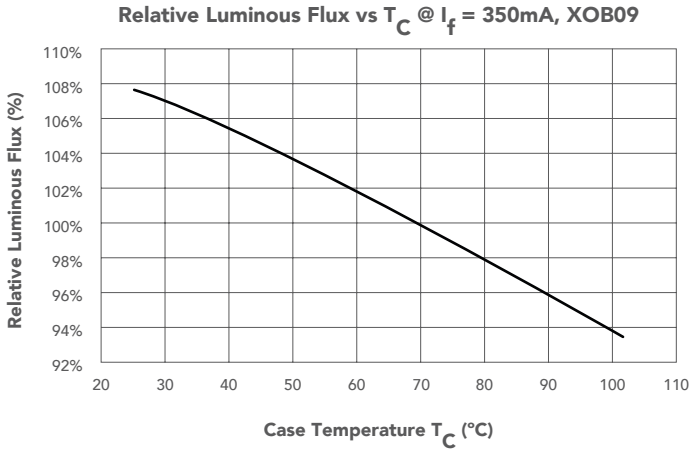
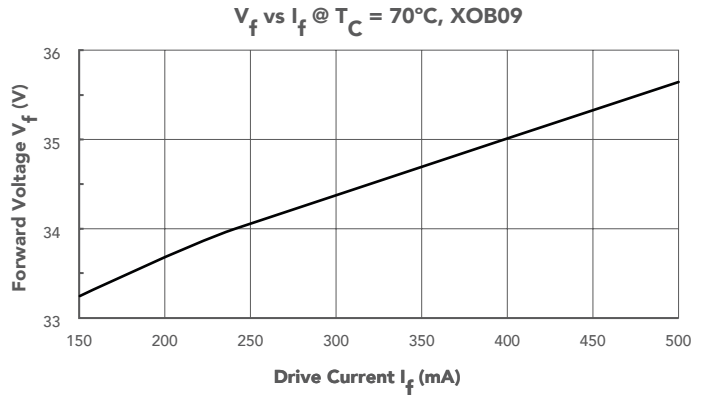
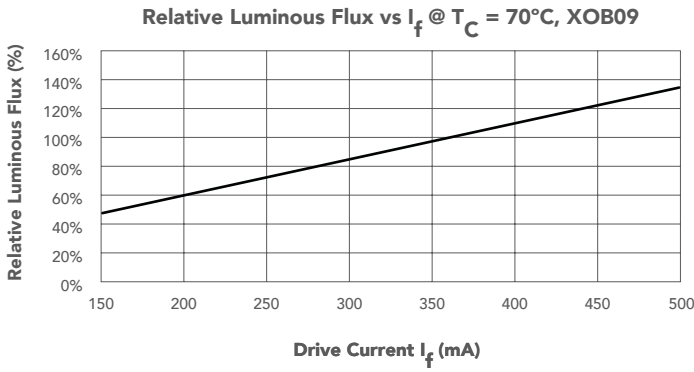

XOB09 Current Derating Curve

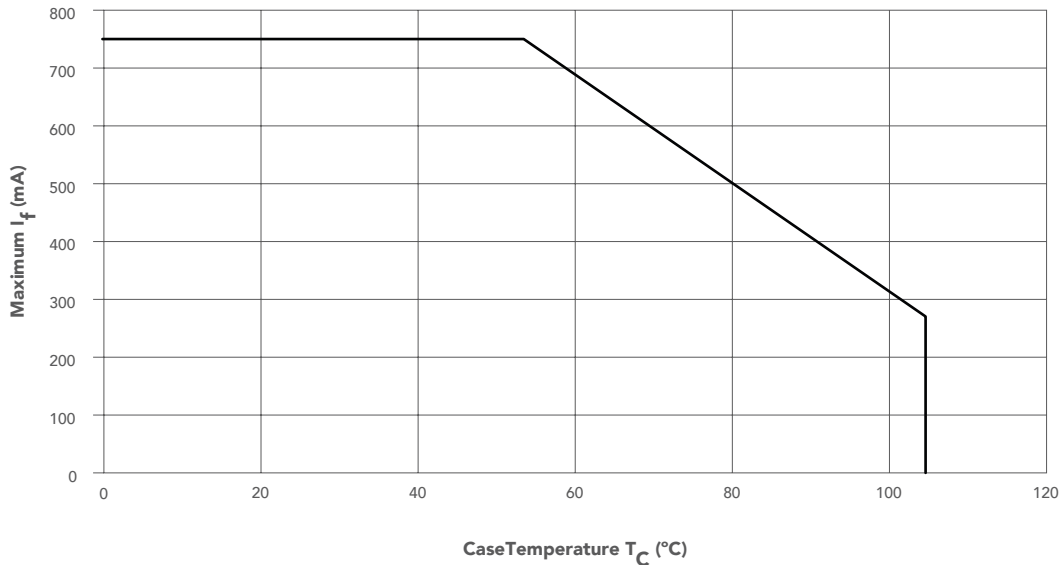

Values in the table above represent 100% relative flux at  $I_f = 350\text{mA}$  and  $T_C = 70^\circ\text{C}$ . To calculate flux under different drive conditions, use the tables and charts above to determine relative flux at different  $I_f$  and  $T_C$  values. For example, in order to calculate the flux when driving a 9.8mm 95 CRI 3000K XOB at  $I_f = 200\text{mA}$  and  $T_C = 50^\circ\text{C}$ , multiply 1,350 lumens by 0.6 and then multiply again by 1.03 to get 834 lumens.  $P = I \cdot V$ , so the efficacy for these drive conditions would be  $(834 \text{ lm}) / (0.200 \text{ A} \cdot 33.7 \text{ V}) = 124 \text{ lm/W}$ .

# Performance Characteristics

XOB14

Series	CRI (Typical)	Part Number	Color Temp	Drive Current	Forward Voltage			Power Consumption (Typical)	Lumen Output (Typical)	Efficacy (Typical)
			(K)	mA	Min	Typ	Max	W	lm	lm/W
XOB 14	90	XOB14902750X3621	2700	1050	30.5	34.2	37.0	35.9	4050	113
				700	30.2	33.9	36.7	23.7	2888	122
				350	29.8	33.5	36.3	11.7	1673	143
		XOB14903050X3621	3000	1050	30.5	34.2	37.0	35.9	4300	120
				700	30.2	33.9	36.7	23.7	3066	129
				350	29.8	33.5	36.3	11.7	1776	151
		XOB14903550X3621	3500	1050	30.5	34.2	37.0	35.9	4600	128
				700	30.2	33.9	36.7	23.7	3280	138
				350	29.8	33.5	36.3	11.7	1900	162
		XOB14904050X3621	4000	1050	30.5	34.2	37.0	35.9	4750	132
				700	30.2	33.9	36.7	23.7	3387	143
				350	29.8	33.5	36.3	11.7	1962	167
	95	XOB14952750X3621	2700	1050	30.5	34.2	37.0	35.9	3650	102
				700	30.2	33.9	36.7	23.7	2602	110
				350	29.8	33.5	36.3	11.7	1507	129
		XOB14953050X3621	3000	1050	30.5	34.2	37.0	35.9	3850	107
				700	30.2	33.9	36.7	23.7	2745	116
				350	29.8	33.5	36.3	11.7	1590	136
		XOB14953550X3621	3500	1050	30.5	34.2	37.0	35.9	4150	115
				700	30.2	33.9	36.7	23.7	2959	125
				350	29.8	33.5	36.3	11.7	1714	146
XOB14954050X3621		4000	1050	30.5	34.2	37.0	35.9	4300	120	
			700	30.2	33.9	36.7	23.7	3066	129	
			350	29.8	33.5	36.3	11.7	1776	151	
V9	XOB14953050V3621	V9	1050	30.5	34.2	37.0	35.9	3850	107	
			700	30.2	33.9	36.7	23.7	2745	116	
			350	29.8	33.5	36.3	11.7	1590	136	

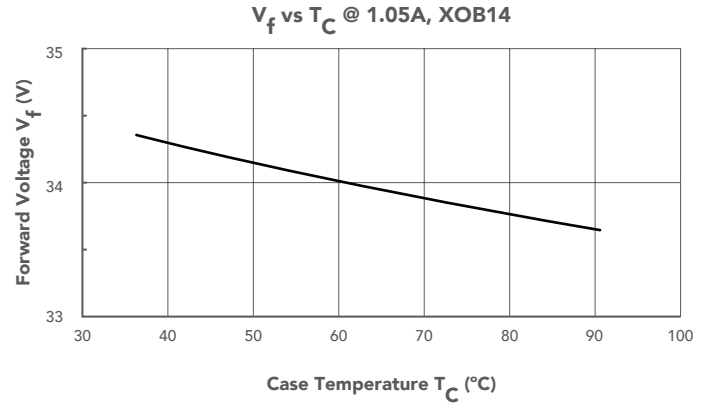
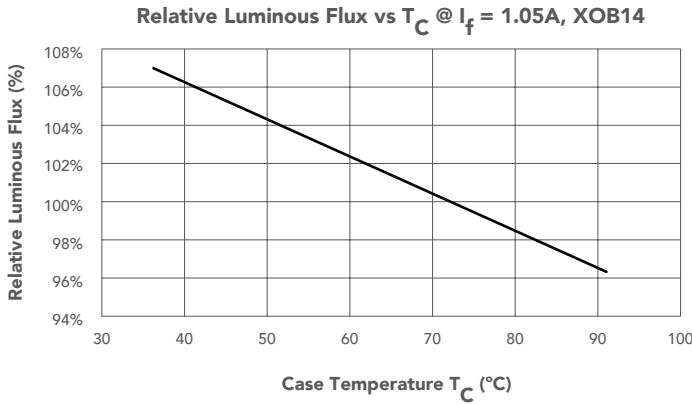
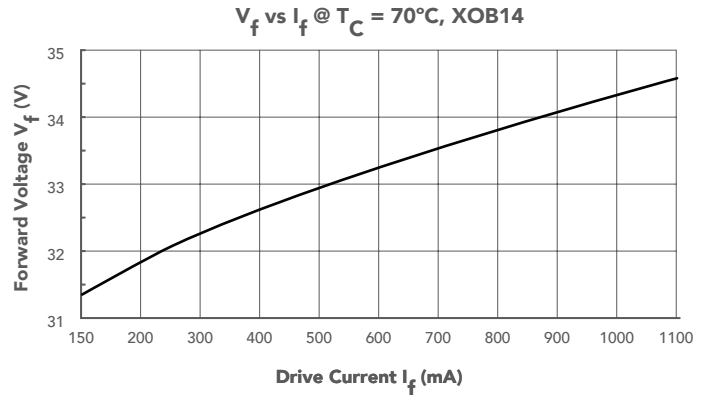
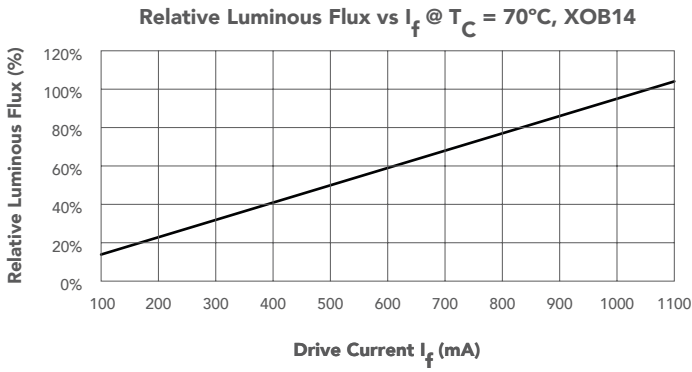

Values in the table above represent 100% relative flux at  $I_f = 1,050\text{mA}$  and  $T_c = 70^\circ\text{C}$ . To calculate flux under different drive conditions, use the tables and charts above to determine relative flux at different  $I_f$  and  $T_c$  values. For example, in order to calculate the flux when driving a 14.5mm 95 CRI 3000K XOB at  $I_f = 200\text{mA}$  and  $T_c = 40^\circ\text{C}$ , multiply 3,850 lumens by 0.21 and then again by 1.06 to get 857 lumens.  $P = I \cdot V$ , so the efficacy for these drive conditions would be  $(857 \text{ lm}) / (0.200 \text{ A} \cdot 34.25 \text{ V}) = 125 \text{ lm/W}$ .

# Performance Characteristics

XOB23

Series	CRI (Typical)	Part Number	Color Temp	Drive Current	Forward Voltage			Power Consumption (Typical)	Lumen Output (Typical)	Efficacy (Typical)							
			(K)	mA	Min	Typ	Max	W	lm	lm/W							
XOB 23	90	XOB23902760X3621	2700	1400	30.6	34.3	37.2	48.1	5733	119							
				1050	30.3	34.0	36.9	35.7	4414	123							
				700	30.1	33.7	36.6	23.6	3096	131							
		XOB23903060X3621	3000	1400	30.6	34.3	37.2	48.1	6038	126							
											1050	30.3	34.0	36.9	35.7	4649	130
											700	30.1	33.7	36.6	23.6	3260	138
		XOB23903560X3621	3500	1400	30.6	34.3	37.2	48.1	6384	133							
											1050	30.3	34.0	36.9	35.7	4916	138
											700	30.1	33.7	36.6	23.6	3447	146
	XOB23904060X3621	4000	1400	30.6	34.3	37.2	48.1	6611	138								
										1050	30.3	34.0	36.9	35.7	5091	142	
										700	30.1	33.7	36.6	23.6	3570	151	
	95	XOB23952760X3621	2700	1400	30.6	34.3	37.2	48.1	5114	106							
											1050	30.3	34.0	36.9	35.7	3937	110
											700	30.1	33.7	36.6	23.6	2761	117
		XOB23953060X3621	3000	1400	30.6	34.3	37.2	48.1	5324	111							
											1050	30.3	34.0	36.9	35.7	4099	115
											700	30.1	33.7	36.6	23.6	2875	122
XOB23953560X3621		3500	1400	30.6	34.3	37.2	48.1	5644	117								
										1050	30.3	34.0	36.9	35.7	4346	122	
										700	30.1	33.7	36.6	23.6	3048	129	
XOB23954060X3621	4000	1400	30.6	34.3	37.2	48.1	5828	121									
									1050	30.3	34.0	36.9	35.7	4487	126		
									700	30.1	33.7	36.6	23.6	3147	133		

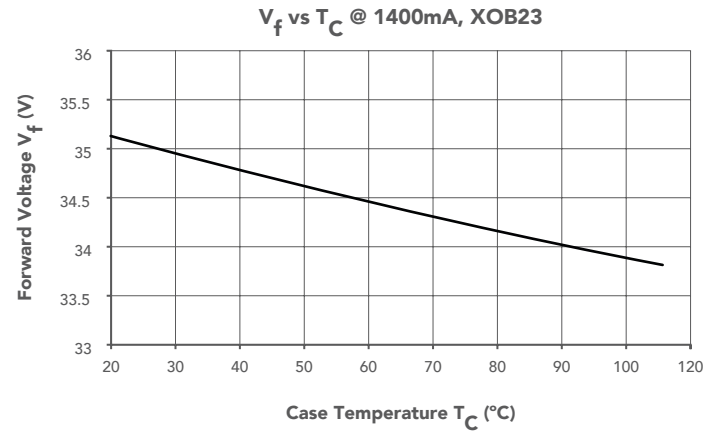
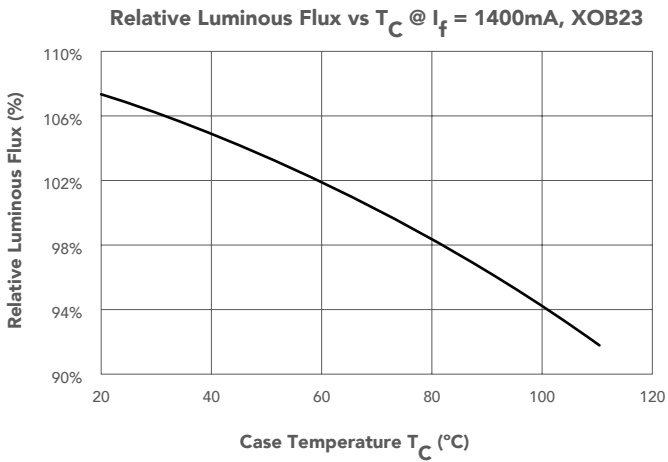
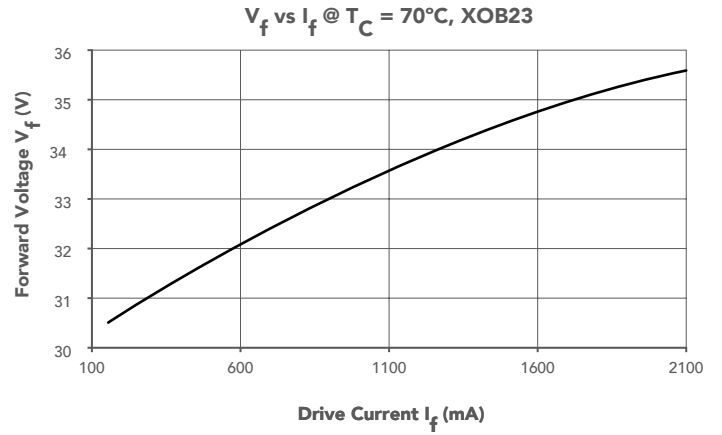
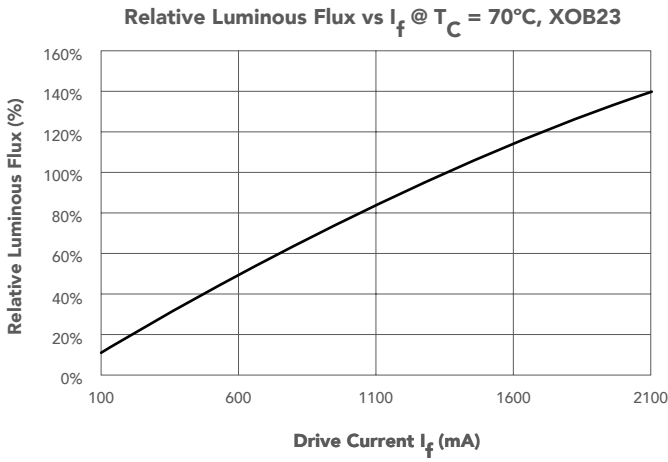

Values in the table above represent 100% relative flux at  $I_f = 1,050\text{mA}$  and  $T_c = 70^\circ\text{C}$ . To calculate flux under different drive conditions, use the tables and charts above to determine relative flux at different  $I_f$  and  $T_c$  values. For example, in order to calculate the flux when driving a 14.5mm 95 CRI 3000K XOB at  $I_f = 200\text{mA}$  and  $T_c = 40^\circ\text{C}$ , multiply 3,850 lumens by 0.21 and then again by 1.06 to get 857 lumens.  $P = I \cdot V$ , so the efficacy for these drive conditions would be  $(857 \text{ lm}) / (0.200 \text{ A} \cdot 34.25 \text{ V}) = 125 \text{ lm/W}$ .

# Performance Characteristics

XOB32

Series	CRI (Typical)	Part Number	Color Temp	Drive Current	Forward Voltage			Power Consumption (Typical)	Lumen Output (Typical)	Efficacy (Typical)							
			(K)	mA	Min	Typ	Max	W	lm	lm/W							
XOB 32	90	XOB32902790X5121	2700	1400	43.0	48.2	52.2	67.5	8310	123							
				1050	42.7	47.9	51.9	50.3	6501	129							
				700	42.4	47.6	51.6	33.3	4514	136							
		XOB32903090X5121	3000	1400	43.0	48.2	52.2	67.5	8610	128							
											1050	42.7	47.9	51.9	50.3	6735	134
											700	42.4	47.6	51.6	33.3	4677	140
		XOB32903590X5121	3500	1400	43.0	48.2	52.2	67.5	8990	133							
											1050	42.7	47.9	51.9	50.3	7033	140
											700	42.4	47.6	51.6	33.3	4884	147
		XOB32904090X5121	4000	1400	43.0	48.2	52.2	67.5	9320	138							
											1050	42.7	47.9	51.9	50.3	7291	145
											700	42.4	47.6	51.6	33.3	5063	152

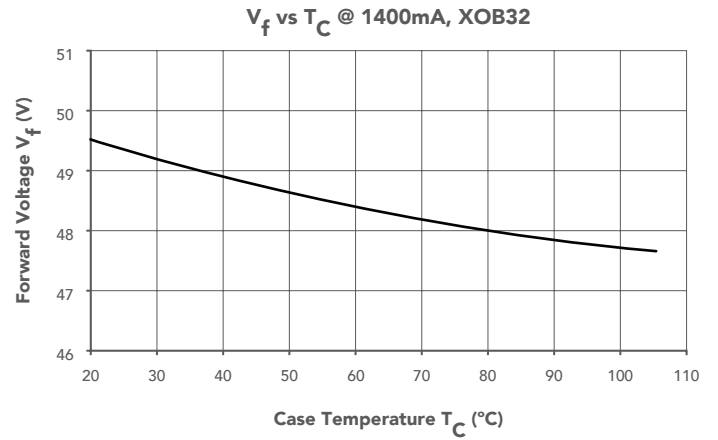
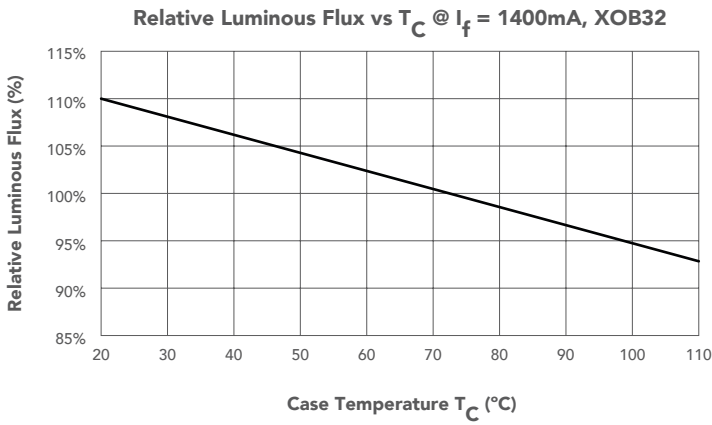
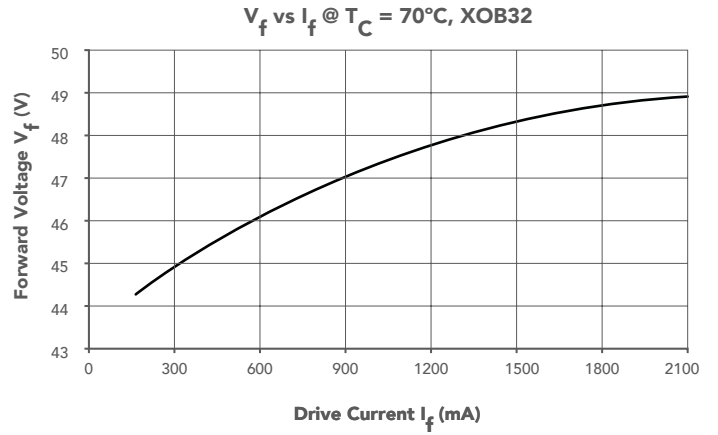
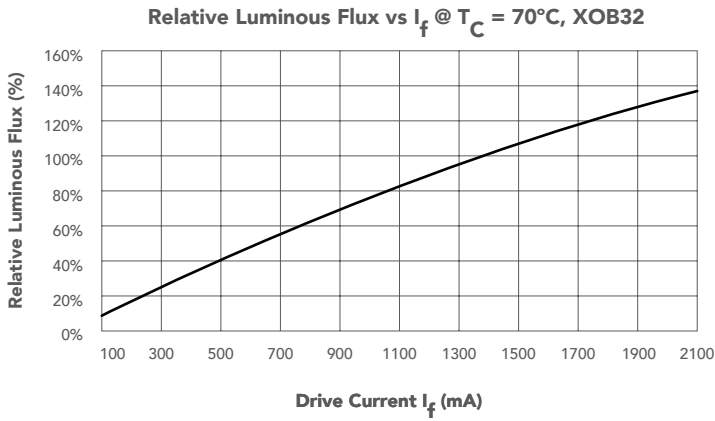

Values in the table above represent 100% relative flux at  $I_f = 1,050\text{mA}$  and  $T_c = 70^\circ\text{C}$ . To calculate flux under different drive conditions, use the tables and charts above to determine relative flux at different  $I_f$  and  $T_c$  values. For example, in order to calculate the flux when driving a 14.5mm 95 CRI 3000K XOB at  $I_f = 200\text{mA}$  and  $T_c = 40^\circ\text{C}$ , multiply 3,850 lumens by 0.21 and then again by 1.06 to get 857 lumens.  $P = I \cdot V$ , so the efficacy for these drive conditions would be  $(857 \text{ lm}) / (0.200 \text{ A} \cdot 34.25 \text{ V}) = 125 \text{ lm/W}$ .

# Color Specifications

Correlated Color Temperature	Nominal	Actual	CCT
	2700K	2700K	± 40K
	3000K	2950K	± 50K
	3500K	3420K	± 60K
	4000K	4000K	± 70K

Initial Color Consistency	SDCM	DUV
	≤ 1x2	± 0.001

XOB matches Xicato Artist color points and are designed to perfectly emulate dimmed incandescent or halogen light sources, with precise color rendering by CIE or IES standards, for the most exacting illumination of art, architecture, people, or other fine materials.



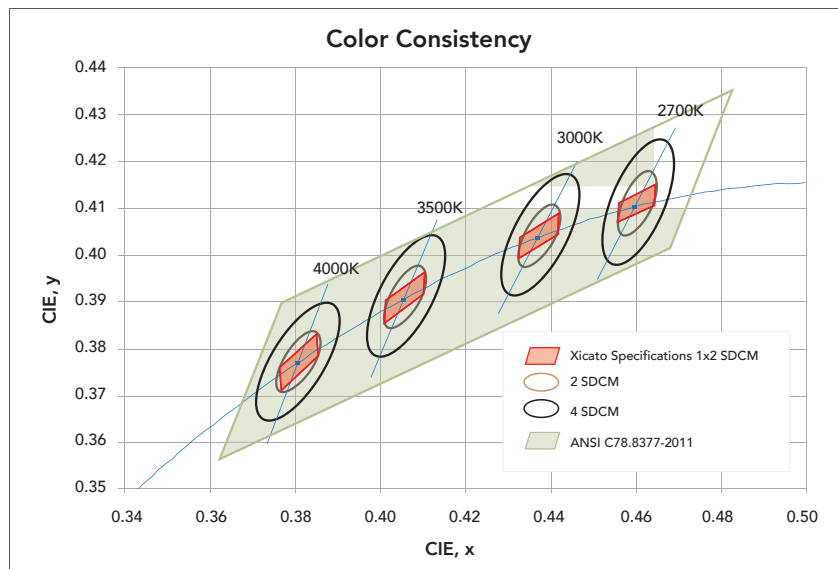

# Color Specifications

## Color Metrics: 90CRI SERIES

Xicato's 90CRI Series is designed to balance extremely high color rendering with high lumen output and efficacy, for demanding retail, hospitality, and residential applications.

All color rendering data at highest rated drive current and 70°C case temperature (Tc).  
 Tester consistency (reproducibility)  $\pm 0.0003$  Duv (CIE 1964) from NIST reference.

<b>Correlated Color Temperature</b>	2700K, 3000K, 3500K, or 4000K nominal 3000K used as test reference
<b>Initial Color Consistency</b>	$\leq 1 \times 2$ Macadam ellipses (SDCM) at 70°C, B0
<b>CIE CRI Minimums</b>	Ra $\geq 90$ , R9 $\geq 50$
<b>TM-30</b>	Rf: 88, Rg: 101 typ

## CIE CRI Color Metrics (values are typical)

	Ra	R1	R2	R3	R4	R5	R6	R7	R8	R9	R10	R11	R12	R13	R14	R15
XCOB 90CRI Series	91	91	94	97	92	91	93	91	80	55	87	93	84	92	98	87

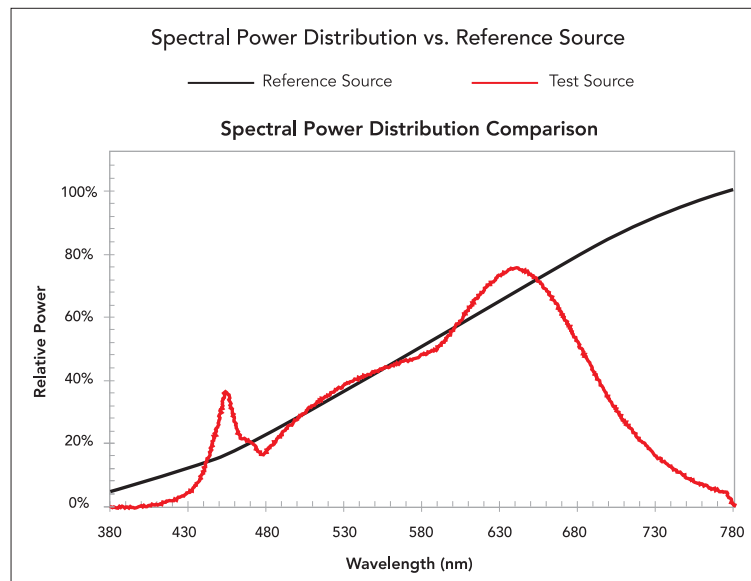

# Color Specifications

## Color Metrics: 95CRI SERIES

Xicato's 95CRI Series is designed to perfectly emulate natural light sources, with precise color rendering by CIE or IES standards, for the most exacting illumination of art, architecture, or other surfaces.

All color rendering data at highest rated drive current and 70°C case temperature (Tc).  
 Tester consistency (reproducibility) ± 0.0003 Duv (CIE 1964) from NIST reference.

<b>Correlated Color Temperature</b>	2700K, 3000K, 3500K, or 4000K nominal 3000K used as test reference
<b>Initial Color Consistency</b>	≤ 1 x 2 Macadam ellipses (SDCM) at 70°C, B0
<b>CIE CRI Minimums</b>	Ra ≥ 95, R9 ≥ 90
<b>TM-30</b>	Rf: 96, Rg: 103 typ

## CIE CRI Color Metrics (values are typical)

	Ra	R1	R2	R3	R4	R5	R6	R7	R8	R9	R10	R11	R12	R13	R14	R15
XCOB 95CRI Series	98	97	99	97	97	97	97	99	97	95	99	95	89	97	97	97

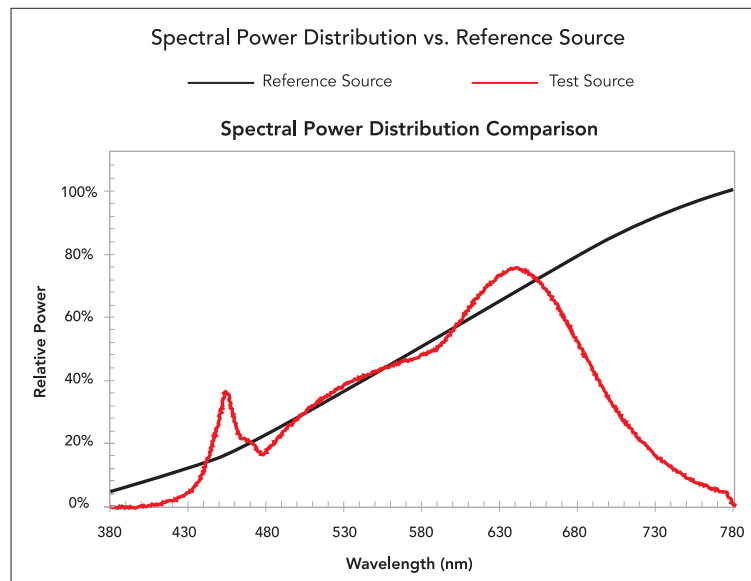

# Mechanical Drawings

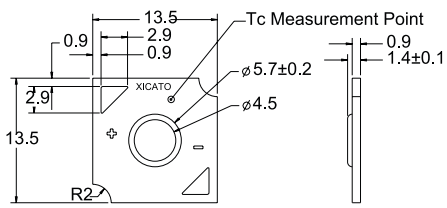

XOB04

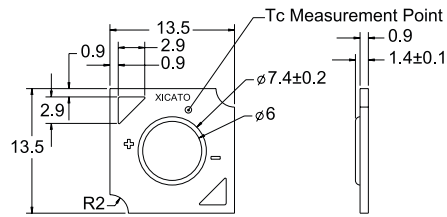

XOB06

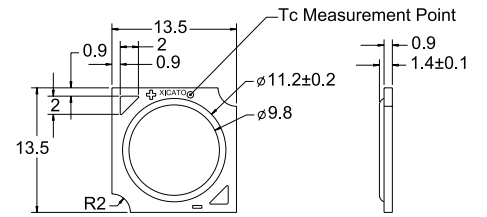

XOB09

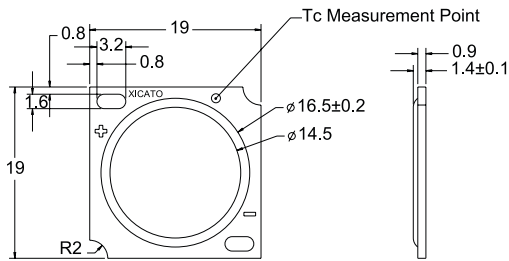

XOB14

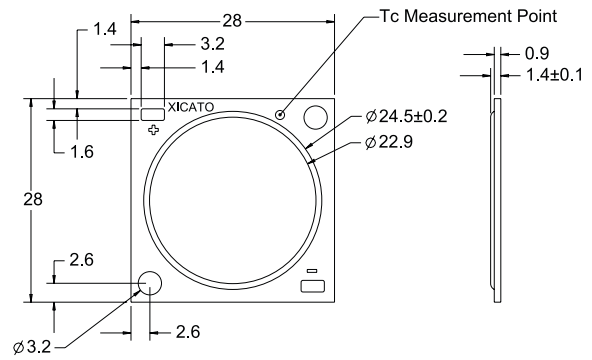

XOB23

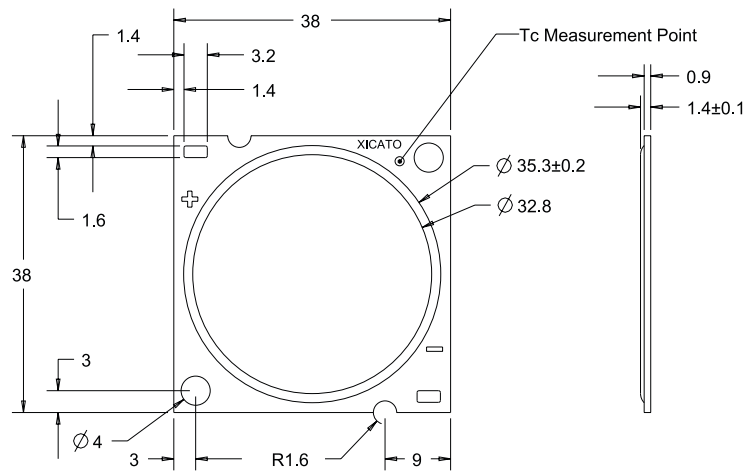

XOB32

# Regulatory Information

## Electrical Safety & Handling

CE	IEC 62031:2008
UL	UL 8750
CSA:	C22.2 No. 250.13
Ingress Protection rating:	IP20
Eye Safety	IEC 62778

## Environmental Safety

RoHS and REACH compliant
--------------------------

## Warranty

Warranty Duration	5 years for lumen maintenance & 2 years for color maintenance
Warranty Coverage	Covers initial color consistency, lumen maintenance, and color maintenance on EVERY light source (B0). No failures.
Initial Color Consistency	Every XOB is within 1x2 MacAdam Ellipse (1x2 SDCM) of target color point. Color point tuned at operating temperature 70°C.
Lumen Maintenance:	Better than 70% (L70, B0, F0) at 50,000 hours at maximum operating drive current and maximum operating temperature (90°C).
Color Maintenance:	All XOB within a contiguous space shall remain within $\pm 0.003 \Delta u'v'$ of each other at maximum operating temperature (90°C) for the duration of the warranty.

Full warranty text at: [xicato.com/support/warranty](http://xicato.com/support/warranty)



**Xicato Global Headquarters**

101 Daggett Drive  
San Jose, CA 95134

**Contact Us**

Tel: +1 866 223 8395  
[info@xicato.com](mailto:info@xicato.com)