

Name **KEMBLEFORD WALL**
 Number **N180**
 Collection **ARTON**

TEKNA

General

Location Indoor
 Main material Brass/glass
 IP rating IP20
 Class I
 Bathroom zone Zone 3
 Voltage 230v
 Driver Required No
 Cable length (m) n/a
 Dimensions (mm/ W-H-D) 74-678-88 / 74-493-88
 Mounting method Wall bracket
 Brut weight (kg) .
 Gross weight (kg) .
 Packing (mm / W-H-D) .
 Energy Efficiency % A



Lamp Included



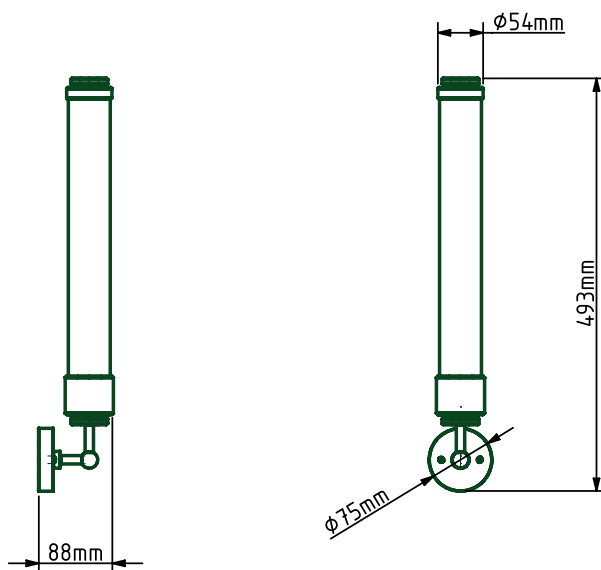



Light source E27 lamp
 Number of light sources 1
 Soket Type E27
 Bulb shape E27 long
 Max Lamp Length .
 power consumption 12w
 Luminous Flux 350-560lm
 Colour Temp 2200K
 CRI 90
 Lifetime 20000h
 Beam angle 330°



Electrical

Swiched No
 Battery No
 Dimmible Yes
 Dimming Range .
 Dimming method Phase dim
 Supply Frequency 50Hz / 60Hz
 Driver/Ballast Voltage n/a
 Efficacy B

Finishes

-  Dark Bronze
-  Sateen Brass
-  Polished Brass
-  Polished Chrome Plated Brass
-  Brushed Chrome Plated Brass Plated
-  Black Mirro Plated Brass

